

SOLD TO:		SHIP TO:	
ADDRESS:		ADDRESS:	
CITY/STATE:		CITY/STATE:	
ZIP CODE:		ZIP CODE:	
PH:	FAX:	PH:	CONTACT:
DATE:	E-MAIL:	TAG:	SHIP VIA:

SLOPES: If slopes are not standard, please show on end & side views <input type="checkbox"/> STANDARD <input type="checkbox"/> CONCAVE <input type="checkbox"/> CONVEX	MIL <input type="checkbox"/> 20 MIL <input type="checkbox"/> 27 MIL <input type="checkbox"/> 30 MIL <input type="checkbox"/> 40 MIL	BEAD <input type="checkbox"/> STANDARD <input type="checkbox"/> STANDARD REVERSE <input type="checkbox"/> ROUND <input type="checkbox"/> ESTHER WILLIAMS <input type="checkbox"/> OVERLAP _____ "	CORNERS <input type="checkbox"/> SQUARE <input type="checkbox"/> DIAGONAL <input type="checkbox"/> RADIUS 90°0' DIAGONAL DISTANCE _____" DIAGONAL DISTANCE (INCHES) RADIUS _____" RADIUS (INCHES)
PATTERN _____			
VINYL COVERED STEPS: <input type="checkbox"/> NO Show location on top view & include stair page <input type="checkbox"/> YES	BOTTOM CONTOUR If bottom contour is not standard, please fill out measurements on page 3 of the Measuring Form	WHITE STRIPE: <input type="checkbox"/> YES <input type="checkbox"/> NO	POOL PERIMETER _____ Perimeter is mandatory for ALL pools

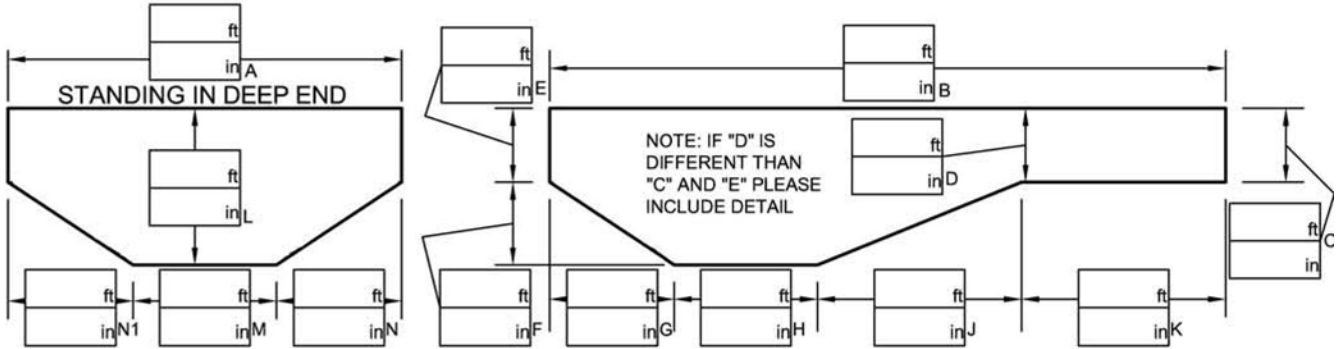

PLEASE INDICATE PREFERRED WALL SEAM LOCATION

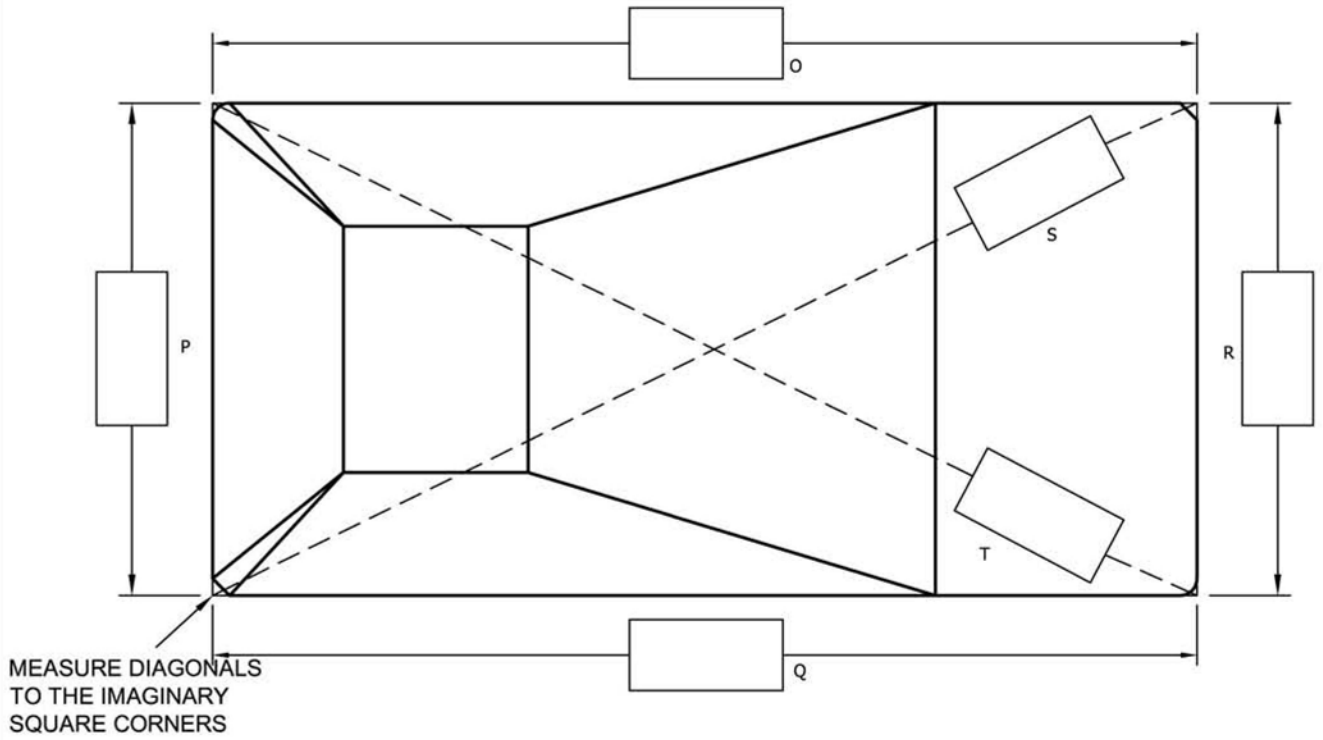

VINYL COVER STRIPS

If steps are another shape than square, please call or e-mail Under the Sun Distribution for an appropriate measuring sheet.

BACK CORNERS

CORNER TYPE	SIZE
<input type="checkbox"/> SQUARE	
<input type="checkbox"/> RADIUS	
<input type="checkbox"/> CUT-OFF	

PLEASE INDICATE LOCATION OF STAIRS ON TOP VIEW OF MEASURING PAGE

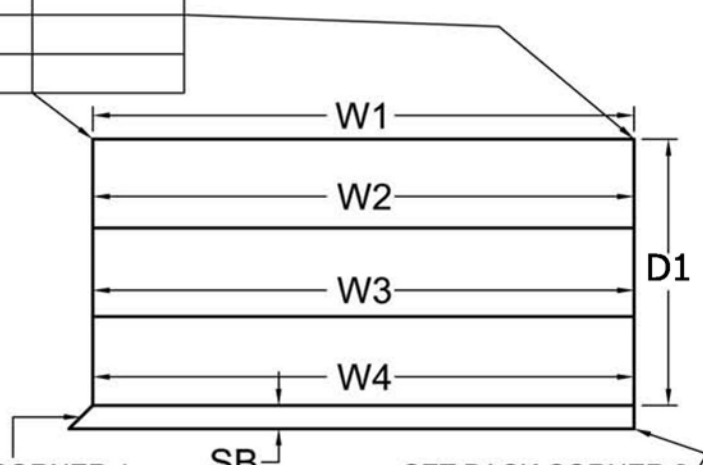

SET BACK CORNER 1

CORNER TYPE	SIZE
<input type="checkbox"/> SQUARE	
<input type="checkbox"/> RADIUS	
<input type="checkbox"/> CUT-OFF	

SET BACK CORNER 2

CORNER TYPE	SIZE
<input type="checkbox"/> SQUARE	
<input type="checkbox"/> RADIUS	
<input type="checkbox"/> CUT-OFF	

MEASUREMENTS

W1	
W2	
W3	
W4	
WH	
D1	
SB	
R1	
R2	
R3	
R4	
T1	
T2	
T3	

NOTE: $R1 + R2 + R3 + R4 = \text{WALL HEIGHT}$
 $T1 + T2 + T3 = \text{DEPTH}$

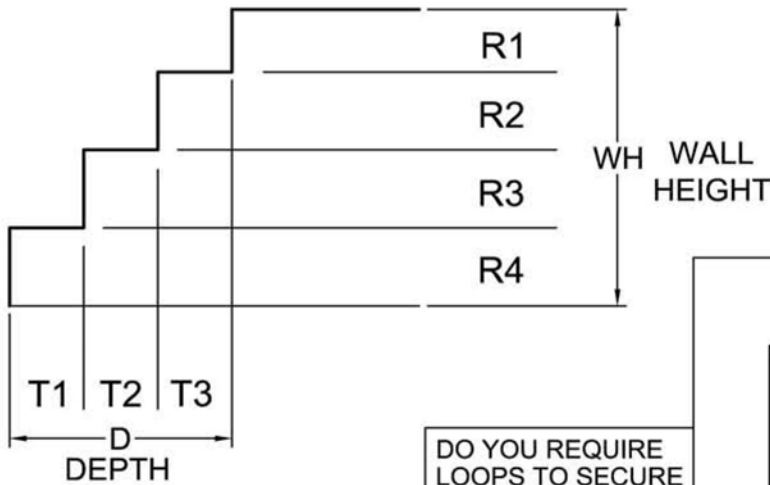

LOCATION OF STEP

CIRCLE ONLY ONE

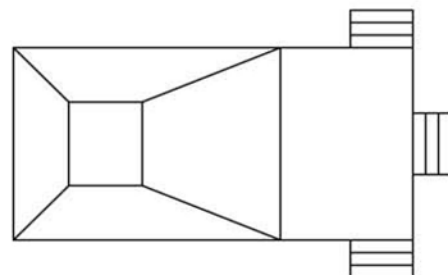

DO YOU REQUIRE LOOPS TO SECURE STAIRS WITH RODS

NO YES

Shallow End Covered Bottom

Fill out this section only if you have a Shallow End Covered Bottom

Use Section 2 as a Measuring Guide and enter your measurements on the diagram.

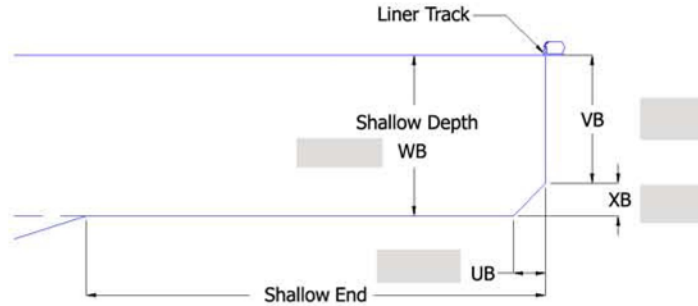

Non-Standard Bottom Profiles

End view is as if you are in the deep end of the pool looking toward the shallow end

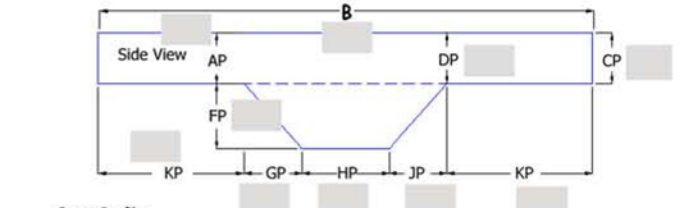
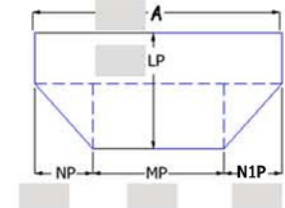
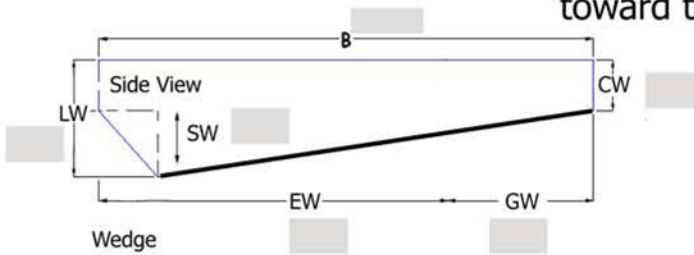
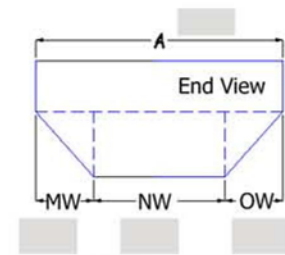

Sport Profile

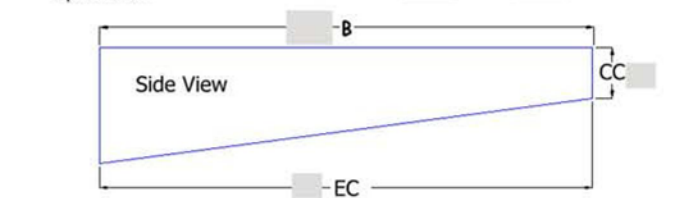
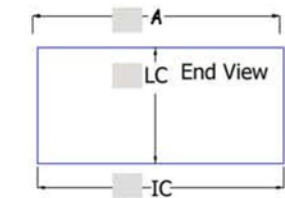

Constant Slope

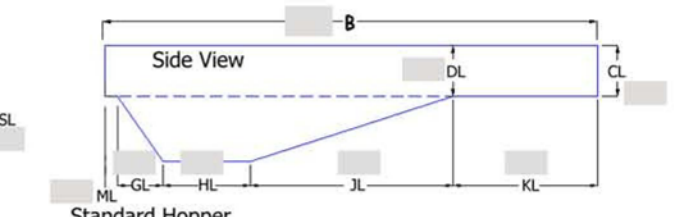
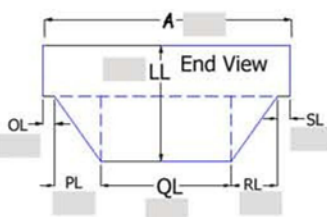

Standard Hopper With Safety Ledge